

Low Emission, Isolated DC-to-DC Converters

FEATURES

- ▶ isoPower integrated, isolated dc-to-dc converter
- ▶ 100 mA output current for ADuM5020
- ▶ 60 mA output current for ADuM5028
- ▶ Meets CISPR22 Class B emissions limits at full load on a 2-layer PCB
- ▶ 16-lead SOIC_W package with 7.8 mm minimum creepage
- ▶ 8-lead SOIC_IC package with 8.3 mm minimum creepage
- ▶ High temperature operation: 125°C maximum
- ▶ Safety and regulatory approvals
 - ▶ UL 1577
 - ▶ $V_{ISO} = 3000$ Vrms for 1 minute
 - ▶ IEC / EN / CSA 62368-1
 - ▶ IEC / CSA 60601-1
 - ▶ IEC / CSA 61010-1
 - ▶ CQC GB 4943.1
 - ▶ DIN EN IEC 60747-17 (VDE 0884-17) (pending)
 - ▶ $V_{IORM} = 565$ Vpeak

APPLICATIONS

- ▶ RS-485/RS-422/CAN transceiver power
- ▶ Power supply start-up bias and gate drives
- ▶ Isolated sensor interfaces
- ▶ Industrial PLCs

GENERAL DESCRIPTION

The ADuM5020 and ADuM5028¹ are isoPower[®], integrated, isolated dc-to-dc converters. Based on the Analog Devices, Inc., iCoupler[®] technology, these dc-to-dc converters provide regulated, isolated power that is below CISPR22 Class B limits at full load on a 2-layer printed circuit board (PCB) with ferrites. Common voltage combinations and the associated current output levels are shown in Table 1 through Table 6.

The ADuM5020 and ADuM5028 eliminate the need to design and build isolated dc-to-dc converters in applications up to 500 mW. The iCoupler chip scale transformer technology is used for the magnetic

FUNCTIONAL BLOCK DIAGRAMS

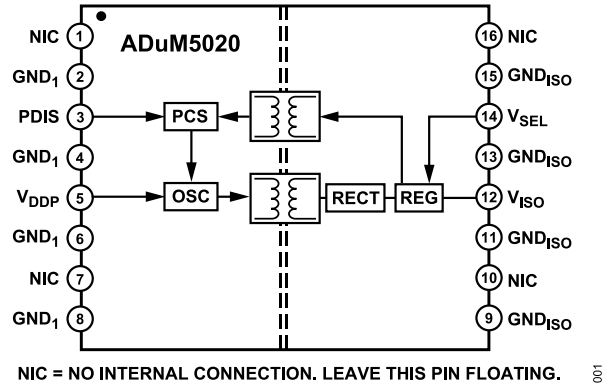

Figure 1. ADuM5020 Functional Block Diagram

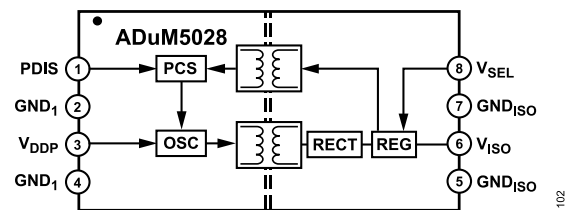

Figure 2. ADuM5028 Functional Block Diagram

components of the dc-to-dc converter. The result is a small form factor, isolated solution.

The ADuM5020 and ADuM5028 isolated dc-to-dc converters provide two different package variants: the ADuM5020 in a wide body, 16-lead SOIC_W package, and the ADuM5028 in the space saving, 8-lead, wide body SOIC_IC. For 5 V input operations, use the ADuM5020-5BRWZ and the ADuM5028-5BRIZ. For 3.3 V input to 3.3 V output ADuM5020, use the ADuM5020-3BRWZ and the ADuM5028-3RIZ. See the Pin Configuration and Function Descriptions section and the Ordering Guide for more information.

¹ Protected by U.S. Patents 5,952,849; 6,873,065; 6,903,578; and 7,075,329. Other patents are pending.

TABLE OF CONTENTS

Features.....	1	DIN EN IEC 60747-17 (VDE 0884-17)	
Applications.....	1	Insulation Characteristics.....	8
Functional Block Diagrams.....	1	Recommended Operating Conditions.....	10
General Description.....	1	Absolute Maximum Ratings.....	11
Specifications.....	3	ESD Caution.....	11
Electrical Characteristics—5 V Primary		Pin Configuration and Function Descriptions.....	12
Input Supply/5 V Secondary Isolated		Typical Performance Characteristics.....	13
Supply.....	3	Theory of Operation.....	16
Electrical Characteristics—5 V Primary		Applications Information.....	17
Input Supply/3.3 V Secondary Isolated		PCB Layout.....	17
Supply.....	4	Thermal Analysis.....	18
Electrical Characteristics—3.3 V Primary		EMI Considerations.....	18
Input Supply/3.3 V Secondary Isolated		Insulation Lifetime.....	18
Supply.....	5	Outline Dimensions.....	20
Regulatory Information.....	6	Ordering Guide.....	20
Insulation and Safety Related Specifications.....	7	Evaluation Boards.....	20
Package Characteristics.....	7		

REVISION HISTORY**9/2024—Rev. B to Rev. C**

Changes to Features Section.....	1
Changed Regulatory Approvals Section to Regulatory Information Section.....	6
Changes to Regulatory Information Section, Table 7, and Table 8.....	6
Changes to Table 9 and Table 10.....	7
Changed DIN V VDE V 0884-10 (VDE V 0884-10) Insulation Characteristics Section to DIN EN IEC 60747-17 (VDE 0884-17) Insulation Characteristics Section.....	8
Changes to DIN EN IEC 60747-17 (VDE 0884-17) Insulation Characteristics Section and Table 13.....	8
Changes to Figure 3 Caption and Figure 4 Caption.....	9
Deleted Maximum Continuous Working Voltage Supporting 50-Year Minimum Lifetime Section and Table 17.....	11
Changes to Calculation and Use of Parameters Example Section.....	19

11/2023—Rev. A to Rev. B

Changes to Features Section.....	1
Changes to Table 7.....	6
Added Table 8; Renumbered Sequentially.....	6

SPECIFICATIONS

ELECTRICAL CHARACTERISTICS—5 V PRIMARY INPUT SUPPLY/5 V SECONDARY ISOLATED SUPPLY

All typical specifications are at $T_A = 25^\circ\text{C}$, $V_{DDP} = V_{ISO} = 5\text{ V}$. Minimum and maximum specifications apply over the entire recommended operation range, which is $4.5\text{ V} \leq V_{DDP} \leq 5.5\text{ V}$, $4.5\text{ V} \leq V_{ISO} \leq 5.5\text{ V}$, and $-40^\circ\text{C} \leq T_A \leq +125^\circ\text{C}$, unless otherwise noted.

Table 1. ADuM5020-5BRIZ DC-to-DC Converter Static Specifications

Parameter	Symbol	Min	Typ	Max	Unit	Test Conditions/Comments
DC-TO-DC CONVERTER SUPPLY						
Setpoint	V_{ISO}	4.75	5.0	5.25	V	V_{ISO} output current (I_{ISO}) = 10 mA
Line Regulation	V_{ISO} (LINE)		2		mV/V	$I_{ISO} = 50\text{ mA}$, $V_{DDP} = 4.5\text{ V}$ to 5.5 V
Load Regulation ¹	V_{ISO} (LOAD)		1	5	%	$I_{ISO} = 10\text{ mA}$ to 90 mA
Output Ripple ¹	V_{ISO} (RIP)		75		mV p-p	20 MHz bandwidth, bypass output capacitance (C_{BO}) = $0.1\ \mu\text{F}$ $10\ \mu\text{F}$, $I_{ISO} = 90\text{ mA}$
Output Noise ¹	V_{ISO} (NOISE)		200		mV p-p	$C_{BO} = 0.1\ \mu\text{F}$ $10\ \mu\text{F}$, $I_{ISO} = 90\text{ mA}$
Switching Frequency	f_{OSC}		180		MHz	
Pulse-Width Modulation (PWM) Frequency	f_{PWM}		625		kHz	
Output Supply Current ¹	I_{ISO} (MAX)	50			mA	$4.75\text{ V} < V_{ISO} < 5.25\text{ V}$
		100			mA	$4.5\text{ V} < V_{ISO} < 5.25\text{ V}$
Efficiency at I_{ISO} (MAX)			33		%	$I_{ISO} = 100\text{ mA}$, $T_A = 25^\circ\text{C}$
V_{DDP} Supply Current						
No V_{ISO} Load	I_{DDP} (Q)		8	25	mA	
Full V_{ISO} Load	I_{DDP} (MAX)		310		mA	
Thermal Shutdown						
Shutdown Temperature			154		$^\circ\text{C}$	
Thermal Hysteresis			10		$^\circ\text{C}$	

¹ Maximum V_{ISO} output current is derated by $1.75\text{ mA}/^\circ\text{C}$ for $T_A > 85^\circ\text{C}$.

Table 2. ADuM5028-5BRIZ DC-to-DC Converter Static Specifications

Parameter	Symbol	Min	Typ	Max	Unit	Test Conditions/Comments
DC-TO-DC CONVERTER SUPPLY						
Setpoint	V_{ISO}	4.75	5.0	5.25	V	$I_{ISO} = 10\text{ mA}$
Line Regulation	V_{ISO} (LINE)		2		mV/V	$I_{ISO} = 30\text{ mA}$, $V_{DDP} = 4.5\text{ V}$ to 5.5 V
Load Regulation ¹	V_{ISO} (LOAD)		1	5	%	$I_{ISO} = 6\text{ mA}$ to 54 mA
Output Ripple ¹	V_{ISO} (RIP)		75		mV p-p	20 MHz bandwidth, $C_{BO} = 0.1\ \mu\text{F}$ $10\ \mu\text{F}$, $I_{ISO} = 54\text{ mA}$
Output Noise ¹	V_{ISO} (NOISE)		200		mV p-p	$C_{BO} = 0.1\ \mu\text{F}$ $10\ \mu\text{F}$, $I_{ISO} = 54\text{ mA}$
Switching Frequency	f_{OSC}		180		MHz	
PWM Frequency	f_{PWM}		625		kHz	
Output Supply Current ¹	I_{ISO} (MAX)	60			mA	$4.75\text{ V} < V_{ISO} < 5.25\text{ V}$
Efficiency at I_{ISO} (MAX)			33		%	$I_{ISO} = 60\text{ mA}$, $T_A = 25^\circ\text{C}$
V_{DDP} Supply Current						
No V_{ISO} Load	I_{DDP} (Q)		8	25	mA	
Full V_{ISO} Load	I_{DDP} (MAX)		190		mA	
Thermal Shutdown						
Shutdown Temperature			154		$^\circ\text{C}$	
Thermal Hysteresis			10		$^\circ\text{C}$	

¹ Maximum V_{ISO} output current is derated by $1\text{ mA}/^\circ\text{C}$ for $T_A > 85^\circ\text{C}$.

SPECIFICATIONS

ELECTRICAL CHARACTERISTICS—5 V PRIMARY INPUT SUPPLY/3.3 V SECONDARY ISOLATED SUPPLY

All typical specifications are at $T_A = 25^\circ\text{C}$, $V_{DDP} = 5.0\text{ V}$, $V_{ISO} = 3.3\text{ V}$. Minimum/maximum specifications apply over the entire recommended operation range, which is $4.5\text{ V} \leq V_{DDP} \leq 5.5\text{ V}$, $3.0\text{ V} \leq V_{ISO} \leq 3.6\text{ V}$, and $-40^\circ\text{C} \leq T_A \leq +125^\circ\text{C}$, unless otherwise noted.

Table 3. ADuM5020-5BRIZ DC-to-DC Converter Static Specifications

Parameter	Symbol	Min	Typ	Max	Unit	Test Conditions/Comments
DC-TO-DC CONVERTER SUPPLY						
Setpoint	V_{ISO}	3.135	3.3	3.465	V	$I_{ISO} = 10\text{ mA}$
Line Regulation	$V_{ISO}(\text{LINE})$		2		mV/V	$I_{ISO} = 50\text{ mA}$, $V_{DDP} = 4.5\text{ V to } 5.5\text{ V}$
Load Regulation ¹	$V_{ISO}(\text{LOAD})$		1	5	%	$I_{ISO} = 10\text{ mA to } 90\text{ mA}$
Output Ripple ¹	$V_{ISO}(\text{RIP})$		50		mV p-p	20 MHz bandwidth, $C_{BO} = 0.1\ \mu\text{F} 10\ \mu\text{F}$, $I_{ISO} = 90\text{ mA}$
Output Noise ¹	$V_{ISO}(\text{NOISE})$		130		mV p-p	$C_{BO} = 0.1\ \mu\text{F} 10\ \mu\text{F}$, $I_{ISO} = 90\text{ mA}$
Switching Frequency	f_{OSC}		180		MHz	
PWM Frequency	f_{PWM}		625		kHz	
Output Supply Current ¹	$I_{ISO}(\text{MAX})$	50			mA	$3.135\text{ V} < V_{ISO} < 3.465\text{ V}$
		100			mA	$3.0\text{ V} < V_{ISO} < 3.465\text{ V}$
Efficiency at $I_{ISO}(\text{MAX})$			27		%	$I_{ISO} = 100\text{ mA}$, $T_A = 25^\circ\text{C}$
V _{DDP} Supply Current						
No V_{ISO} Load	$I_{DDP}(\text{Q})$		5	18	mA	
Full V_{ISO} Load	$I_{DDP}(\text{MAX})$		250		mA	
Thermal Shutdown						
Shutdown Temperature			154		$^\circ\text{C}$	
Thermal Hysteresis			10		$^\circ\text{C}$	

¹ Maximum V_{ISO} output current is derated by $1.75\text{ mA}/^\circ\text{C}$ for $T_A > 85^\circ\text{C}$.

Table 4. ADuM5028-5BRIZ DC-to-DC Converter Static Specifications

Parameter	Symbol	Min	Typ	Max	Unit	Test Conditions/Comments
DC-TO-DC CONVERTER SUPPLY						
Setpoint	V_{ISO}	3.135	3.3	3.465	V	$I_{ISO} = 10\text{ mA}$
Line Regulation	$V_{ISO}(\text{LINE})$		2		mV/V	$I_{ISO} = 30\text{ mA}$, $V_{DDP} = 4.5\text{ V to } 5.5\text{ V}$
Load Regulation ¹	$V_{ISO}(\text{LOAD})$		1	5	%	$I_{ISO} = 6\text{ mA to } 54\text{ mA}$
Output Ripple ¹	$V_{ISO}(\text{RIP})$		50		mV p-p	20 MHz bandwidth, $C_{BO} = 0.1\ \mu\text{F} 10\ \mu\text{F}$, $I_{ISO} = 54\text{ mA}$
Output Noise ¹	$V_{ISO}(\text{NOISE})$		130		mV p-p	$C_{BO} = 0.1\ \mu\text{F} 10\ \mu\text{F}$, $I_{ISO} = 54\text{ mA}$
Switching Frequency	f_{OSC}		180		MHz	
PWM Frequency	f_{PWM}		625		kHz	
Output Supply Current ¹	$I_{ISO}(\text{MAX})$	30			mA	$3.135\text{ V} < V_{ISO} < 3.465\text{ V}$
		60			mA	$3.0\text{ V} < V_{ISO} < 3.465\text{ V}$
Efficiency at $I_{ISO}(\text{MAX})$			27		%	$I_{ISO} = 60\text{ mA}$, $T_A = 25^\circ\text{C}$
V _{DDP} Supply Current						
No V_{ISO} Load	$I_{DDP}(\text{Q})$		5	18	mA	
Full V_{ISO} Load	$I_{DDP}(\text{MAX})$		150		mA	
Thermal Shutdown						
Shutdown Temperature			154		$^\circ\text{C}$	
Thermal Hysteresis			10		$^\circ\text{C}$	

¹ Maximum V_{ISO} output current is derated by $1\text{ mA}/^\circ\text{C}$ for $T_A > 85^\circ\text{C}$.

SPECIFICATIONS

ELECTRICAL CHARACTERISTICS—3.3 V PRIMARY INPUT SUPPLY/3.3 V SECONDARY ISOLATED SUPPLY

All typical specifications are at $T_A = 25^\circ\text{C}$, $V_{DDP} = 3.3\text{ V}$, $V_{ISO} = 3.3\text{ V}$. Minimum/maximum specifications apply over the entire recommended operation range, which is $3.0\text{ V} \leq V_{DDP} \leq 3.6\text{ V}$, $3.0\text{ V} \leq V_{ISO} \leq 3.6\text{ V}$, and $-40^\circ\text{C} \leq T_A \leq +125^\circ\text{C}$, unless otherwise noted.

Table 5. ADuM5020-3BRWZ DC-to-DC Converter Static Specifications

Parameter	Symbol	Min	Typ	Max	Unit	Test Conditions/Comments
DC-TO-DC CONVERTER SUPPLY						
Setpoint	V_{ISO}	3.135	3.3	3.465	V	$I_{ISO} = 10\text{ mA}$
Line Regulation	$V_{ISO}(\text{LINE})$		2		mV/V	$I_{ISO} = 50\text{ mA}$, $V_{DDP} = 3.0\text{ V to }3.6\text{ V}$
Load Regulation ¹	$V_{ISO}(\text{LOAD})$		1	5	%	$I_{ISO} = 7\text{ mA to }63\text{ mA}$
Output Ripple ¹	$V_{ISO}(\text{RIP})$		50		mV p-p	20 MHz bandwidth, $C_{BO} = 0.1\ \mu\text{F} 10\ \mu\text{F}$, $I_{ISO} = 90\text{ mA}$
Output Noise ¹	$V_{ISO}(\text{NOISE})$		130		mV p-p	$C_{BO} = 0.1\ \mu\text{F} 10\ \mu\text{F}$, $I_{ISO} = 90\text{ mA}$
Switching Frequency	f_{OSC}		180		MHz	
PWM Frequency	f_{PWM}		625		kHz	
Output Supply Current ¹	$I_{ISO}(\text{MAX})$	35			mA	$3.135\text{ V} < V_{ISO} < 3.465\text{ V}$
		70			mA	$3.0\text{ V} < V_{ISO} < 3.465\text{ V}$
Efficiency at $I_{ISO}(\text{MAX})$			33		%	$I_{ISO} = 70\text{ mA}$, $T_A = 25^\circ\text{C}$
V _{DDP} Supply Current						
No V_{ISO} Load	$I_{DDP}(\text{Q})$		5	15	mA	
Full V_{ISO} Load	$I_{DDP}(\text{MAX})$		225		mA	
Thermal Shutdown						
Shutdown Temperature			154		$^\circ\text{C}$	
Thermal Hysteresis			10		$^\circ\text{C}$	

¹ Maximum V_{ISO} output current is derated by $2\text{ mA}/^\circ\text{C}$ for $T_A > 105^\circ\text{C}$.

Table 6. ADuM5028-3BRIZ DC-to-DC Converter Static Specifications

Parameter	Symbol	Min	Typ	Max	Unit	Test Conditions/Comments
DC-TO-DC CONVERTER SUPPLY						
Setpoint	V_{ISO}	3.135	3.3	3.465	V	$I_{ISO} = 10\text{ mA}$
Line Regulation	$V_{ISO}(\text{LINE})$		2		mV/V	$I_{ISO} = 30\text{ mA}$, $V_{DDP} = 3.0\text{ V to }3.6\text{ V}$
Load Regulation ¹	$V_{ISO}(\text{LOAD})$		1	5	%	$I_{ISO} = 6\text{ mA to }54\text{ mA}$
Output Ripple ¹	$V_{ISO}(\text{RIP})$		50		mV p-p	20 MHz bandwidth, $C_{BO} = 0.1\ \mu\text{F} 10\ \mu\text{F}$, $I_{ISO} = 54\text{ mA}$
Output Noise ¹	$V_{ISO}(\text{NOISE})$		130		mV p-p	$C_{BO} = 0.1\ \mu\text{F} 10\ \mu\text{F}$, $I_{ISO} = 54\text{ mA}$
Switching Frequency	f_{OSC}		180		MHz	
PWM Frequency	f_{PWM}		625		kHz	
Output Supply Current ¹	$I_{ISO}(\text{MAX})$	30			mA	$3.135\text{ V} < V_{ISO} < 3.465\text{ V}$
		60			mA	$3.0\text{ V} < V_{ISO} < 3.465\text{ V}$
Efficiency at $I_{ISO}(\text{MAX})$			33		%	$I_{ISO} = 60\text{ mA}$, $T_A = 25^\circ\text{C}$
V _{DDP} Supply Current						
No V_{ISO} Load	$I_{DDP}(\text{Q})$		5	15	mA	
Full V_{ISO} Load	$I_{DDP}(\text{MAX})$		190		mA	
Thermal Shutdown						
Shutdown Temperature			154		$^\circ\text{C}$	
Thermal Hysteresis			10		$^\circ\text{C}$	

¹ Maximum V_{ISO} output current is derated by $2\text{ mA}/^\circ\text{C}$ for $T_A > 105^\circ\text{C}$.

SPECIFICATIONS

REGULATORY INFORMATION

The ADuM5020 certification approvals are listed in [Table 7](#). The ADuM5028 certification approvals are listed in [Table 8](#).

Table 7. RW-16 Wide-Body [SOIC_W] Package

Regulatory Agency	Standard Certification/Approval	File
UL ¹	1577 ¹ Single protection, 3000 V rms	File E214100
CSA	IEC / EN / 62368-1 Basic insulation, 780 V rms Reinforced insulation, 390 V rms IEC / CSA 61010-1 Basic insulation, 600 V rms Reinforced insulation, 300 V rms IEC / CSA 60601-1 Basic insulation (1 MOPP), 419 V rms Reinforced insulation (2 MOPP), 50 V rms	File 205078
TÜV SÜD	IEC / EN 62368-1 Basic insulation, 780 V rms Reinforced insulation, 390 V rms	Certificate No. B 056232 0021
VDE (Pending) ²	DIN EN IEC 60747-17 (VDE 0884-17) Reinforced insulation, 565 V peak	Certificate No. (pending)
CQC	CQC GB4943.1: Basic insulation, 780 V rms Reinforced insulation, 390 V rms	Certificate No: CQC21001283893

¹ In accordance with UL 1577, each ADuM5020 and ADuM5028 are proof tested by applying an insulation test voltage ≥ 3600 V rms for 1 sec.

² In accordance with DIN EN IEC 60747-17 (VDE 0884-17), each ADuM5020 and ADuM5028 are proof tested by applying an insulation test voltage ≥ 1059 V peak for 1 sec (partial discharge detection limit = 5 pC). The * marking branded on the component designates DIN EN IEC 60747-17 (VDE 0884-17) approval.

Table 8. RI-8 Wide-Body with Increased Creepage [SOIC_IC] Package

Regulatory Agency	Standard Certification/Approval	File
UL ¹	1577 ¹ Single protection, 3000 V rms	File E214100
CSA	IEC / EN / CSA 62368-1 Basic insulation, 600 V rms Reinforced insulation, 300 V rms IEC / CSA 60601-1 Basic insulation (1MOPP), 419 V rms IEC / CSA 61010-1 Basic insulation, 600 V rms Reinforced insulation, 300 V rms	File 205078
TÜV SÜD	IEC / EN 62368-1 Basic insulation, 600 V rms Reinforced insulation, 300 V rms	Certificate No: B 056232 0021
VDE (Pending) ²	DIN EN IEC 60747-17 (VDE 0884-17) Reinforced insulation, 565 V peak	Certificate No. (pending)
CQC	CQC GB4943.1: Basic insulation, 780 V rms Reinforced insulation, 390 V rms	Certificate No: CQC21001283892

¹ In accordance with UL 1577, each ADuM5020 and ADuM5028 are proof tested by applying an insulation test voltage ≥ 3600 V rms for 1 sec.

SPECIFICATIONS

² In accordance with DIN EN IEC 60747-17 (VDE 0884-17), each ADuM5020 and ADuM5028 are proof tested by applying an insulation test voltage ≥ 1059 V peak for 1 sec (partial discharge detection limit = 5 pC). The * marking branded on the component designates DIN EN IEC 60747-17 (VDE 0884-17) approval.

INSULATION AND SAFETY RELATED SPECIFICATIONS

For additional information, see www.analog.com/icouplersafety.

Table 9. ADuM5020 Insulation and Safety

Parameter	Symbol	Value	Unit	Test Conditions/Comments
Rated Dielectric Insulation Voltage		3000	V rms	1-minute duration
Minimum External Air Gap (Clearance) ^{1,2}	L (I01)	7.8	mm	Measured from input terminals to output terminals, shortest distance through air
Minimum External Tracking (Creepage) ¹	L (I02)	7.8	mm	Measured from input terminals to output terminals, shortest distance path along body
Minimum Clearance in the Plane of the Printed Circuit Board (PCB Clearance)	L (PCB)	8.3	mm	Measured from input terminals to output terminals, shortest distance through air, line of sight, in the PCB mounting plane
Minimum Internal Gap (Internal Clearance)		21.5	μm	Insulation distance through insulation
Tracking Resistance (Comparative Tracking Index) ³	CTI	>600	V	DIN IEC 112/VDE 0303 Part 1
Material Group		I		Material Group (DIN VDE 0110, 1/89, Table 1)

¹ In accordance with IEC 62368-1 / IEC 60601-1 guidelines for the measurement of creepage and clearance distances for a pollution degree of 2 and altitudes ≤ 2000 m.

² Consideration must be given to pad layout to ensure the minimum required distance for clearance is maintained.

³ CTI rating for the ADuM5020/ADuM5028 is >600 V and a Material Group I isolation group.

Table 10. ADuM5028 Insulation and Safety

Parameter	Symbol	Value	Unit	Test Conditions/Comments
Rated Dielectric Insulation Voltage		3000	V rms	1-minute duration
Minimum External Air Gap (Clearance) ^{1,2}	L (I01)	8.3	mm	Measured from input terminals to output terminals, shortest distance through air
Minimum External Tracking (Creepage) ¹	L (I02)	8.3	mm	Measured from input terminals to output terminals, shortest distance path along body
Minimum Clearance in the Plane of the Printed Circuit Board (PCB Clearance)	L (PCB)	8.3	mm	Measured from input terminals to output terminals, shortest distance through air, line of sight, in the PCB mounting plane
Minimum Internal Gap (Internal Clearance)		21.5	μm	Insulation distance through insulation
Tracking Resistance (Comparative Tracking Index) ³	CTI	>600	V	DIN IEC 112/VDE 0303 Part 1
Material Group		I		Material Group (DIN VDE 0110, 1/89, Table 1)

¹ In accordance with IEC 62368-1 / IEC 60601-1 guidelines for the measurement of creepage and clearance distances for a pollution degree of 2 and altitudes ≤ 2000 m.

² Consideration must be given to pad layout to ensure the minimum required distance for clearance is maintained.

³ CTI rating for the ADuM5020/ADuM5028 is >600 V and a Material Group I isolation group.

PACKAGE CHARACTERISTICS

Table 11. ADuM5020 Package Characteristics

Parameter	Symbol	Min	Typ	Max	Unit	Test Conditions/Comments
Resistance (Input to Output) ¹	R_{I-O}		10^{13}		Ω	
Capacitance (Input to Output) ¹	C_{I-O}		2.2		pF	f = 1 MHz
Input Capacitance ²	C_I		4.0		pF	
IC Junction to Ambient Thermal Resistance	θ_{JA}		45		$^{\circ}\text{C/W}$	Thermocouple located at center of package underside ³

¹ This device is considered a 2-terminal device: Pin 1 through Pin 8 are shorted together, and Pin 9 through Pin 16 are shorted together.

² Input capacitance is from any input data pin to ground.

SPECIFICATIONS

³ The value of θ_{JA} is based on devices mounted on a JEDEC JESD-51 standard 2s2p board and still air.

Table 12. ADuM5028 Package Characteristics

Parameter	Symbol	Min	Typ	Max	Unit	Test Conditions/Comments
Resistance (Input to Output) ¹	R_{I-O}		10 ¹³		Ω	
Capacitance (Input to Output) ¹	C_{I-O}		2.2		pF	f = 1 MHz
Input Capacitance ²	C_I		4.0		pF	
IC Junction to Ambient Thermal Resistance	θ_{JA}		80		$^{\circ}\text{C/W}$	Thermocouple located at center of package underside ³

¹ This device is considered a 2-terminal device: Pin 1 through Pin 4 are shorted together, and Pin 5 through Pin 8 are shorted together.

² Input capacitance is from any input data pin to ground.

³ The value of θ_{JA} is based on devices mounted on a JEDEC JESD-51 standard 2s2p board and still air.

DIN EN IEC 60747-17 (VDE 0884-17) INSULATION CHARACTERISTICS

These isolators are suitable for reinforced electrical isolation only within the safety limit data. Maintenance of the safety data is ensured by the protective circuits. The asterisk (*) marking on packages denotes DIN EN IEC 60747-17 (VDE 0884-17) approval.

Table 13. ADuM5020 VDE Characteristics

Description	Test Conditions/Comments	Symbol	Characteristic	Unit
Installation Classification per DIN VDE 0110				
For Rated Mains Voltage ≤ 150 V rms			I to IV	
For Rated Mains Voltage ≤ 300 V rms			I to III	
For Rated Mains Voltage ≤ 400 V rms			I to II	
Climatic Classification			40/125/21	
Pollution Degree per DIN VDE 0110, Table 1			2	
Maximum Repetitive Isolation Voltage		V_{IORM}	565	V peak
Maximum Working Insulation Voltage		V_{IOWM}	400	V rms
Input to Output Test Voltage, Method b1	$V_{IORM} \times 1.875 = V_{PR}$, 100% production test, $t_m = 1$ sec, partial discharge < 5 pC	V_{PR}	1059	V peak
Input to Output Test Voltage, Method a				
After Environmental Tests Subgroup 1	$V_{IORM} \times 1.6 = V_{pd(m)}$, $t_{ini} = 60$ sec, $t_m = 10$ sec, partial discharge < 5 pC	$V_{pd(m)}$	904	V peak
After Input or Safety Test Subgroup 2 and Subgroup 3	$V_{IORM} \times 1.2 = V_{pd(m)}$, $t_{ini} = 60$ sec, $t_m = 10$ sec, partial discharge < 5 pC	$V_{pd(m)}$	678	V peak
Maximum Transient Isolation Voltage		V_{IOTM}	4242	V peak
Maximum Impulse Voltage	Tested in air, 1.2 $\mu\text{s}/50$ μs waveform per IEC 61000-4-5	V_{IMP}	4242	V peak
Withstand Isolation Voltage	1 minute withstand rating	V_{ISO}	3000	V rms
Maximum Surge Isolation Voltage Reinforced	Tested in oil, 1.2 $\mu\text{s}/50$ μs waveform per IEC 61000-4-5, $V_{TEST} = V_{IOSM} \times 1.3$ OR ≥ 10 kV	V_{IOSM}	10000	V peak
Safety Limiting Values	Maximum value allowed in the event of a failure (see Figure 3)			
Case Temperature		T_S	150	$^{\circ}\text{C}$
Total Power Dissipation at 25 $^{\circ}\text{C}$		I_{S1}	2.78	W
Insulation Resistance at T_S	$V_{IO} = 500$ V	R_S	$>10^9$	Ω

Table 14. ADuM5028 VDE Characteristics

Description	Test Conditions/Comments	Symbol	Characteristic	Unit
Installation Classification per DIN VDE 0110				
For Rated Mains Voltage ≤ 150 V rms			I to IV	
For Rated Mains Voltage ≤ 300 V rms			I to III	
For Rated Mains Voltage ≤ 400 V rms			I to II	

SPECIFICATIONS

Table 14. ADuM5028 VDE Characteristics (Continued)

Description	Test Conditions/Comments	Symbol	Characteristic	Unit
Climatic Classification			40/125/21	
Pollution Degree per DIN VDE 0110, Table 1			2	
Maximum Repetitive Isolation Voltage		V_{IORM}	565	V peak
Maximum Working Insulation Voltage		V_{IOWM}	400	V rms
Input to Output Test Voltage, Method b1	$V_{IORM} \times 1.875 = V_{PR}$, 100% production test, $t_m = 1$ sec, partial discharge < 5 pC	V_{PR}	1059	V peak
Input to Output Test Voltage, Method a After Environmental Tests Subgroup 1	$V_{IORM} \times 1.6 = V_{pd(m)}$, $t_{ni} = 60$ sec, $t_m = 10$ sec, partial discharge < 5 pC	$V_{pd(m)}$	904	V peak
After Input and/or Safety Test Subgroup 2and Subgroup 3	$V_{IORM} \times 1.2 = V_{pd(m)}$, $t_{ni} = 60$ sec, $t_m = 10$ sec, partial discharge < 5 pC	$V_{pd(m)}$	678	V peak
Maximum Transient Isolation Voltage		V_{IOTM}	4242	V peak
Maximum Impulse Voltage	Tested in air, 1.2 μ s/50 μ s waveform per IEC 61000-4-5	V_{IMP}	4242	V peak
Withstand Isolation Voltage	1 minute withstand rating	V_{ISO}	3000	V rms
Maximum Surge Isolation Voltage Reinforced	Tested in oil, 1.2 μ s/50 μ s waveform per IEC 61000-4-5, $V_{TEST} = V_{IOSM} \times 1.3$ OR ≥ 10 kV	V_{IOSM}	10000	V peak
Safety Limiting Values	Maximum value allowed in the event of a failure (see Figure 4)			
Case Temperature		T_S	150	$^{\circ}$ C
Total Power Dissipation at 25 $^{\circ}$ C		I_{S1}	1.56	W
Insulation Resistance at T_S	$V_{IO} = 500$ V	R_S	>10 ⁹	Ω

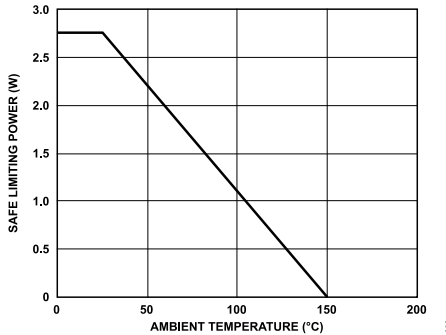

Figure 3. ADuM5020 Thermal Derating Curve, Dependence of Safety Limiting Values with Ambient Temperature per DIN EN IEC 60747-17 (VDE 0884-17)

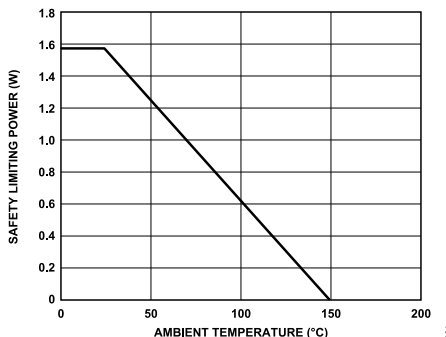

Figure 4. ADuM5028 Thermal Derating Curve, Dependence of Safety Limiting Values with Ambient Temperature per DIN EN IEC 60747-17 (VDE 0884-17)

SPECIFICATIONS

RECOMMENDED OPERATING CONDITIONS

Table 15.

Parameter	Symbol	Min	Typ	Max	Unit
Operating Temperature ¹	T_A	-40		+125	°C
Supply Voltages ²	V_{DDP}				
ADuM5020-5BRWZ, ADuM5028-5BRIZ, V_{DDP} at $V_{ISO} = 3.135$ V to 3.465 V		4.5		5.5	V
ADuM5020-3BRWZ, ADuM5028-3BRIZ, V_{DDP} at $V_{ISO} = 3.135$ V to 3.465 V		3.0		3.6	V
ADuM5020-5BRWZ, ADuM5028-5BRIZ, V_{DDP} at $V_{ISO} = 4.75$ V to 5.25 V		4.5		5.5	V

¹ Operation at >85°C requires reduction of the maximum load current.

² Each voltage is relative to its respective ground.

ABSOLUTE MAXIMUM RATINGS

$T_A = 25^\circ\text{C}$, unless otherwise noted.

Table 16.

Parameter	Rating
Storage Temperature (T_{ST})	-55°C to $+150^\circ\text{C}$
Ambient Operating Temperature (T_A)	-40°C to $+125^\circ\text{C}$
Supply Voltages (V_{DDP} , V_{ISO}) ¹	-0.5 V to $+7.0\text{ V}$
V_{ISO} Supply Current	
ADuM5020	100 mA
ADuM5028	60 mA
Input Voltage (PDIS, V_{SEL}) ^{1,2}	-0.5 V to $V_{DDI} + 0.5\text{ V}$
Common-Mode Transients ³	$-200\text{ kV}/\mu\text{s}$ to $+200\text{ kV}/\mu\text{s}$

¹ All voltages are relative to their respective ground.

² V_{DDI} is the input side supply voltage.

³ Common-mode transients refer to common-mode transients across the insulation barrier. Common-mode transients exceeding the absolute maximum ratings may cause latch-up or permanent damage.

Stresses at or above those listed under Absolute Maximum Ratings may cause permanent damage to the product. This is a stress rating only; functional operation of the product at these or any other conditions above those indicated in the operational section of this specification is not implied. Operation beyond the maximum operating conditions for extended periods may affect product reliability.

ESD CAUTION

ESD (electrostatic discharge) sensitive device. Charged devices and circuit boards can discharge without detection. Although this product features patented or proprietary protection circuitry, damage may occur on devices subjected to high energy ESD. Therefore, proper ESD precautions should be taken to avoid performance degradation or loss of functionality.

PIN CONFIGURATION AND FUNCTION DESCRIPTIONS

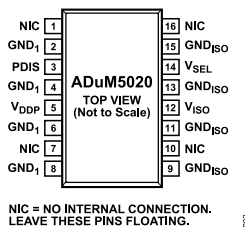

Figure 5. ADuM5020 Pin Configuration

Table 17. ADuM5020 Pin Function Descriptions

Pin No.	Mnemonic	Description
1, 7, 10, 16	NIC	No Internal Connection. Leave these pins floating.
2, 4, 6, 8	GND ₁	Ground 1. Ground reference for the primary. It is recommended that these pins be connected to a common ground.
3	PDIS	Power Disable. When tied to any GND ₁ pin, the V _{ISO} output voltage is active. When a logic high voltage is applied, the V _{ISO} output voltage is shut down. Do not leave this pin floating.
5	V _{DDP}	Primary Supply Voltage.
9, 11, 13, 15	GND _{ISO}	Ground Reference for V _{ISO} on Side 2. It is recommended that these pins be connected to a common ground.
12	V _{ISO}	Secondary Supply Voltage Output for External Loads.
14	V _{SEL}	Output Voltage Selection. Connect V _{SEL} to V _{ISO} for 5 V output or connect V _{SEL} to GND _{ISO} for 3.3 V output. This pin has a weak internal pull-up. Therefore, do not leave this pin floating. It is recommended that the ADuM5020-3BRWZ and the ADuM5028-3BRIZ are only used for 3.3 V input to 3.3 V operation, therefore connect V _{SEL} to GND _{ISO} .

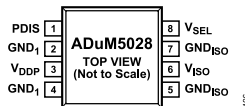

Figure 6. ADuM5028 Pin Configuration

Table 18. ADuM5028 Pin Function Descriptions

Pin No.	Mnemonic	Description
1	PDIS	Power Disable. When tied to any GND ₁ pin, the V _{ISO} output voltage is active. When a logic high voltage is applied, the V _{ISO} output voltage is shut down. Do not leave this pin floating.
2, 4	GND ₁	Ground 1. Ground reference for the primary. It is recommended that these pins be connected to a common ground.
3	V _{DDP}	Primary Supply Voltage.
5, 7	GND _{ISO}	Ground Reference for V _{ISO} on Side 2. It is recommended that these pins be connected together.
6	V _{ISO}	Secondary Supply Voltage Output for External Loads.
8	V _{SEL}	Output Voltage Selection. Connect V _{SEL} to V _{ISO} for 5 V output or connect V _{SEL} to GND _{ISO} for 3.3 V output. This pin has a weak internal pull-up; therefore, do not leave this pin floating. It is recommended that the ADuM5020-3BRWZ and the ADuM5028-3BRIZ are only used for 3.3 V input to 3.3 V operation, therefore connect V _{SEL} to GND _{ISO} .

Table 19. Truth Table (Positive Logic)

V _{DDP} (V)	V _{SEL} Input	PDIS Input	V _{ISO} Output (V)	Notes
5	High	Low	5	
5	Low	Low	3.3	
5	Don't care	High	0	
3.3	Low	Low	3.3	
3.3	High	Low	5	Configuration not recommended
3.3	Don't care	High	0	

TYPICAL PERFORMANCE CHARACTERISTICS

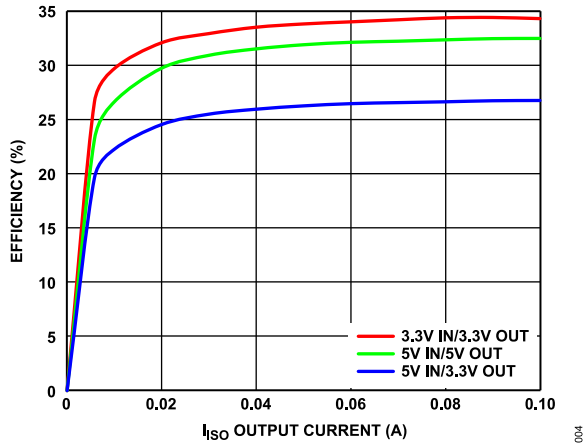

Figure 7. Typical Power Supply Efficiency in Supported Supply Configurations

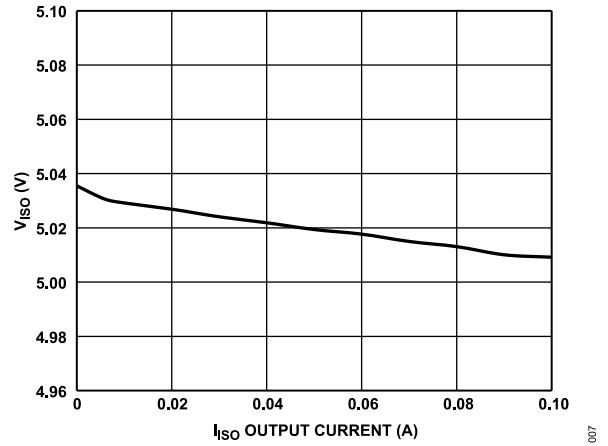

Figure 10. V_{ISO} vs. I_{ISO} Output Current, Input = 5 V, V_{ISO} = 5 V

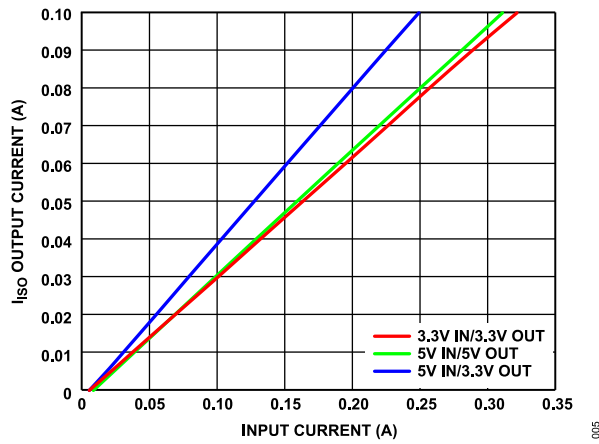

Figure 8. I_{ISO} Output Current vs. Input Current in Supported Power Configurations

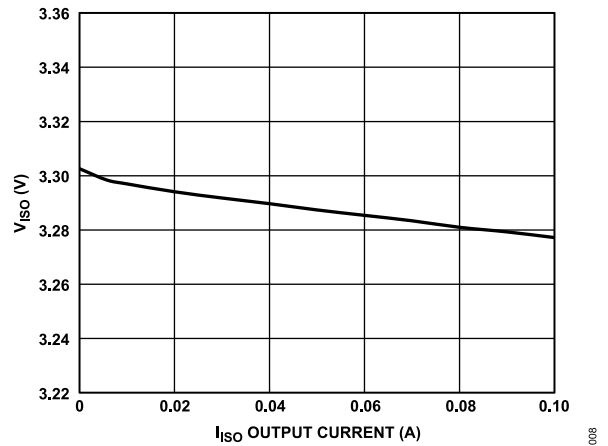

Figure 11. V_{ISO} vs. I_{ISO} Output Current, Input = 5 V, V_{ISO} = 3.3 V

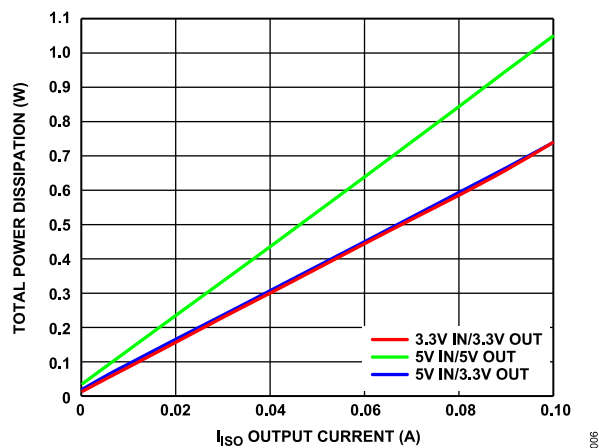

Figure 9. Total Power Dissipation vs. I_{ISO} Output Current in Supported Power Configurations

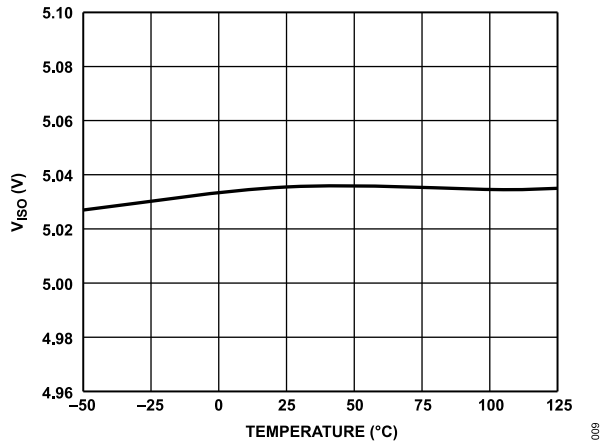

Figure 12. V_{ISO} vs. Temperature, Input = 5 V, V_{ISO} Output = 5 V

TYPICAL PERFORMANCE CHARACTERISTICS

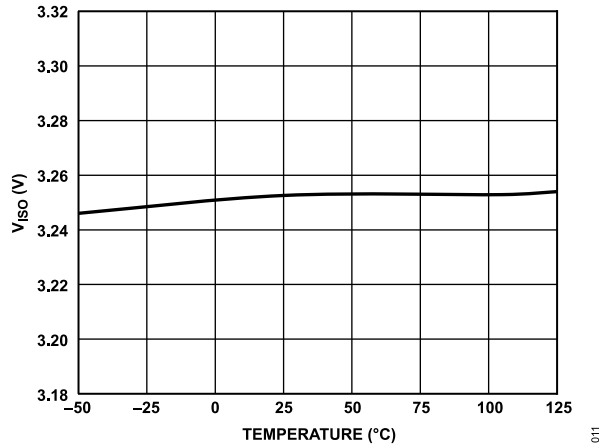

Figure 13. V_{ISO} vs. Temperature, Input = 3.3 V, V_{ISO} Output = 3.3 V

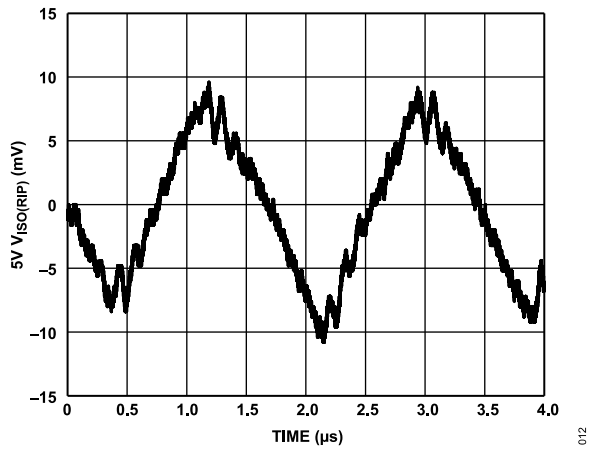

Figure 14. V_{ISO} Ripple, 5 V Input to 5 V Output at 90% Load, Bandwidth = 20 MHz

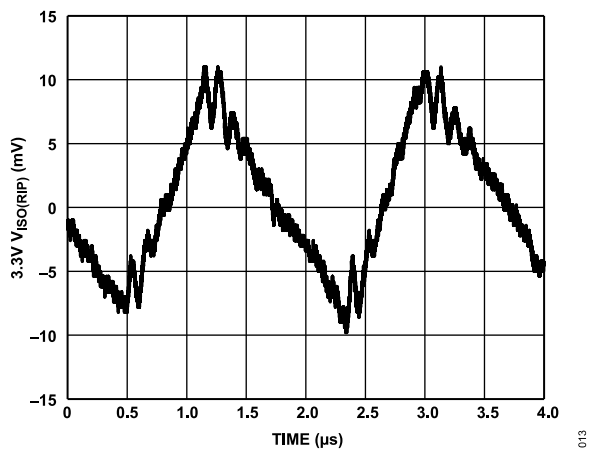

Figure 15. V_{ISO} Ripple, 5 V Input to 3.3 V Output at 90% Load, Bandwidth = 20 MHz

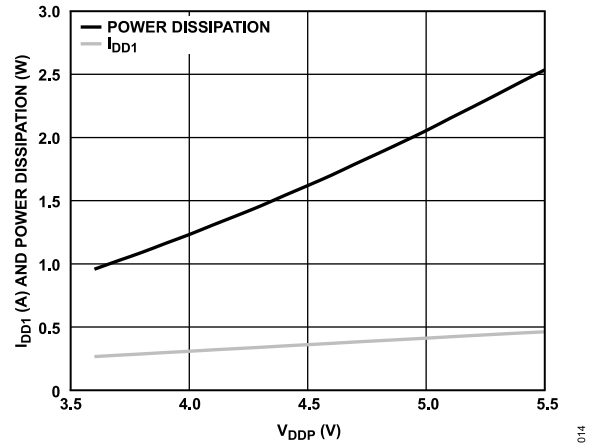

Figure 16. Short-Circuit Input Current (I_{DD1}) and Power Dissipation vs. V_{DDP}

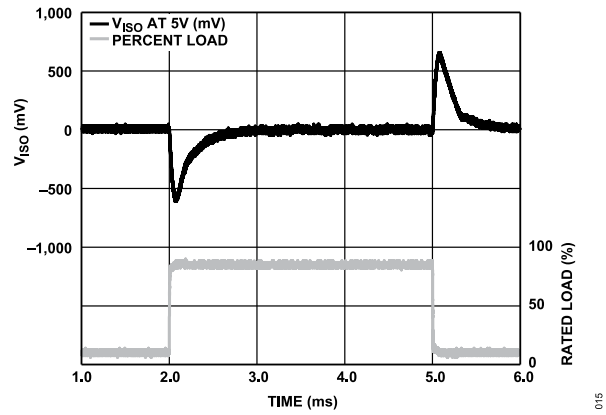

Figure 17. V_{ISO} Transient Load Response 5 V Input to 5 V Output 10% to 90% Load Step

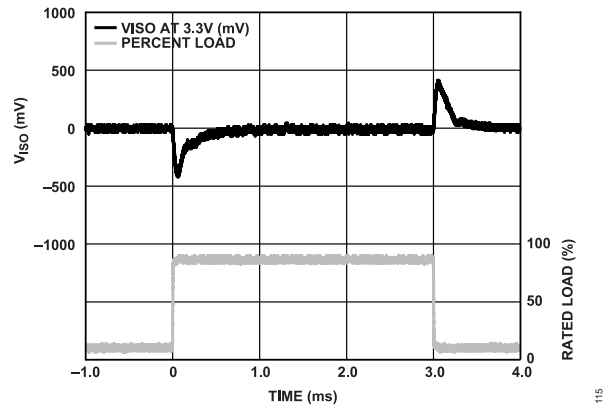

Figure 18. V_{ISO} Transient Load Response 5 V Input to 3.3 V Output, 10% to 90% Load Step

TYPICAL PERFORMANCE CHARACTERISTICS

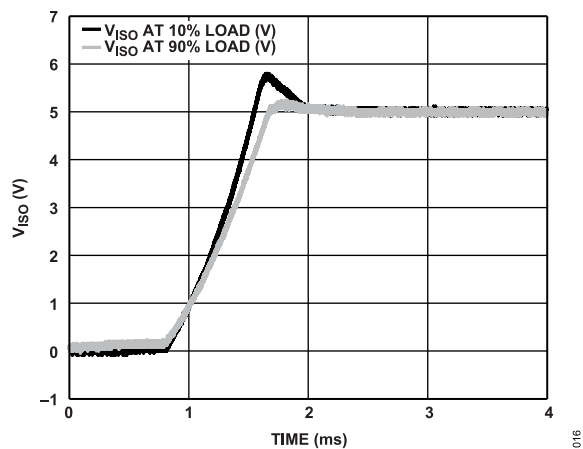

Figure 19. 5 V Input to 5 V Output V_{ISO} Start-Up Transient at 10% and 90% Load

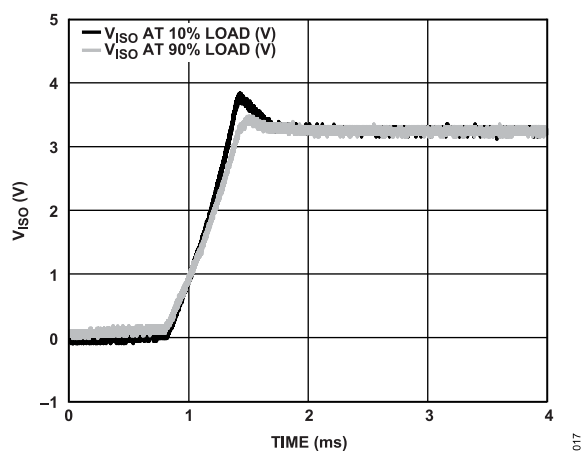

Figure 20. 5 V Input to 3.3 V Output V_{ISO} Start-Up Transient at 10% and 90% Load

THEORY OF OPERATION

The ADuM5020/ADuM5028 dc-to-dc work on principles that are common to most standard power supplies. The converters have a split controller architecture with isolated PWM feedback. V_{DDP} power is supplied to an oscillating circuit that switches current into a chip scale air core transformer. Power transferred to the secondary side is rectified and regulated to 3.3 V or 5.0 V, depending on the setting of the V_{SEL} pin. Note that the ADuM5020-3BRWZ and the ADuM5028-3BRIZ can only be used for 3.3 V input to 3.3 V output applications, and the ADuM5020-5BRWZ and ADuM5028-5BRIZ operate best for 5 V input applications. The secondary (V_{ISO}) side controller regulates the output by creating a PWM control signal

that is sent to the primary (V_{DDP}) side by a dedicated *iCoupler* data channel. The PWM modulates the oscillator circuit to control the power being sent to the secondary side. Feedback allows significantly higher power and efficiency.

The ADuM5020/ADuM5028 implement undervoltage lockout (UVLO) with hysteresis on the primary and secondary side input and output pins as well as the V_{DDP} power input. The UVLO feature ensures that the converters do not go into oscillation due to noisy input power or slow power-on ramp rates.

APPLICATIONS INFORMATION

PCB LAYOUT

The ADuM5020 and ADuM5028 *isoPower* integrated dc-to-dc converters require power supply bypassing at the input and output supply pins (see Figure 21 and Figure 22). Low effective series resistance (ESR) 0.1 μF bypass capacitors are required between the V_{DDP} pin and GND_1 pin, as close to the chip pads as possible. Low ESR 0.1 μF or 0.22 μF capacitors are required between the V_{ISO} pin and GND_{ISO} pin, as close to the chip pads as possible (see the C_{ISO} note in Figure 23 and Figure 24 for more information). The *isoPower* inputs require multiple passive components to bypass the power effectively, as well as set the output voltage and bypass the core voltage regulator (see Figure 21 through Figure 26).

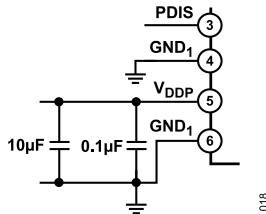

Figure 21. ADuM5020 V_{DDP} Bias and Bypass Components

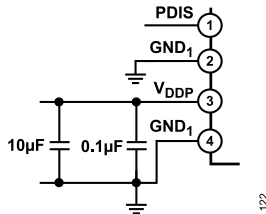
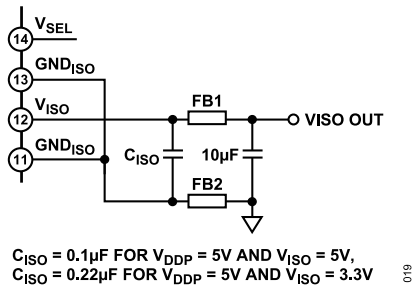
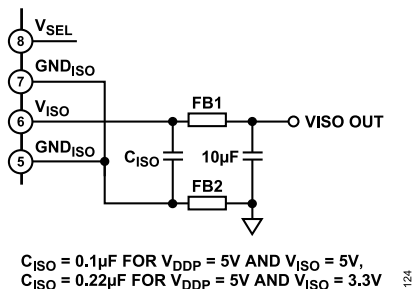

Figure 22. ADuM5028 V_{DDP} Bias and Bypass Components



$C_{ISO} = 0.1\mu\text{F}$ FOR $V_{DDP} = 5\text{V}$ AND $V_{ISO} = 5\text{V}$,
 $C_{ISO} = 0.22\mu\text{F}$ FOR $V_{DDP} = 5\text{V}$ AND $V_{ISO} = 3.3\text{V}$

Figure 23. ADuM5020 V_{ISO} Bias and Bypass Components



$C_{ISO} = 0.1\mu\text{F}$ FOR $V_{DDP} = 5\text{V}$ AND $V_{ISO} = 5\text{V}$,
 $C_{ISO} = 0.22\mu\text{F}$ FOR $V_{DDP} = 5\text{V}$ AND $V_{ISO} = 3.3\text{V}$

Figure 24. ADuM5028 V_{ISO} Bias and Bypass Components

The power supply section of the ADuM5020 and ADuM5028 uses a 180 MHz oscillator frequency to efficiently pass power through its chip scale transformers. Bypass capacitors are required for several operating frequencies. Noise suppression requires a low inductance, high frequency capacitor, whereas ripple suppression and proper regulation require a large value capacitor. These capacitors are most conveniently connected between the V_{DDP} pin and GND_1 pin, and between the V_{ISO} pin and GND_{ISO} pin. To suppress noise and reduce ripple, a parallel combination of at least two capacitors is required. The recommended capacitor values are 0.1 μF and 10 μF for V_{DDP} and V_{ISO} . The smaller capacitor must have a low ESR. For example, use of a ceramic capacitor is advised. The total lead length between the ends of the 0.1 μF low ESR capacitors, and the power supply pins must not exceed 2 mm.

To reduce the level of electromagnetic radiation, the impedance to high frequency currents between the V_{ISO} and GND_{ISO} pins and the PCB trace connections can be increased. Using this method of electromagnetic interference (EMI) suppression controls the radiating signal at its source by placing surface-mount ferrite beads in series with the V_{ISO} and GND_{ISO} pins, as shown in Figure 25 and Figure 26. The impedance of the ferrite bead is chosen to be about 1.8 k Ω between the 100 MHz and 1 GHz frequency range to reduce the emissions at the 180 MHz primary switching frequency and the 360 MHz secondary side rectifying frequency and harmonics. See Table 20 for examples of appropriate surface-mount ferrite beads.

Table 20. Surface-Mount Ferrite Beads Example

Manufacturer	Part No.
Taiyo Yuden	BKH1005LM182-T
Murata Electronics	BLM15HD182SN1

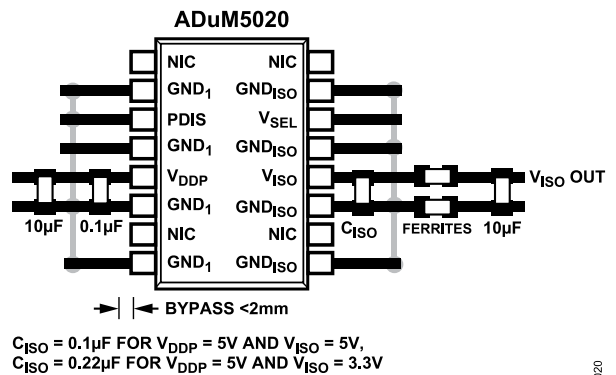

$C_{ISO} = 0.1\mu\text{F}$ FOR $V_{DDP} = 5\text{V}$ AND $V_{ISO} = 5\text{V}$,
 $C_{ISO} = 0.22\mu\text{F}$ FOR $V_{DDP} = 5\text{V}$ AND $V_{ISO} = 3.3\text{V}$

Figure 25. Recommended ADuM5020 PCB Layout

APPLICATIONS INFORMATION

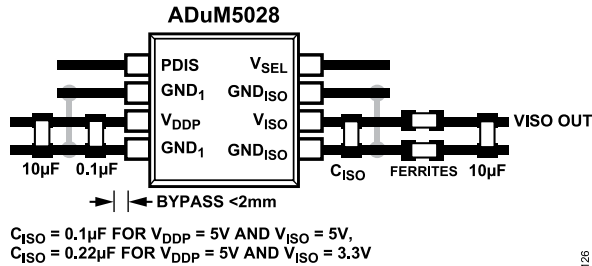

Figure 26. Recommended ADuM5028 PCB Layout

In applications involving high common-mode transients, ensure that board coupling across the isolation barrier is minimized. Furthermore, design the board layout such that any coupling that does occur equally affects all pins on a given component side. Failure to ensure these steps can cause voltage differentials between pins, exceeding the absolute maximum ratings specified in [Table 16](#), thereby leading to latch-up or permanent damage.

THERMAL ANALYSIS

The ADuM5020 and ADuM5028 each consist of three internal die attached to a split lead frame. For thermal analysis, the die is treated as a thermal unit, with the highest junction temperature reflected in the θ_{JA} values, shown in [Table 11](#) and [Table 12](#). The value of θ_{JA} is based on measurements taken with the devices mounted on a JEDEC standard, 4-layer board with fine width traces and still air. Under normal operating conditions, the ADuM5020 and ADuM5028 can operate at full load, but at temperatures greater than 85°C, derating the output current may be needed, as shown in [Figure 3](#) and [Figure 4](#).

EMI CONSIDERATIONS

The ADuM5020/ADuM5028 dc-to-dc converters must, of necessity, operate at a high frequency to allow efficient power transfer through the small transformers. This high frequency operation creates high frequency currents that can propagate in circuit board ground and power planes, requiring proper power supply bypassing at the input and output supply pins (see [Figure 25](#) and [Figure 26](#)). Using proper layout, bypassing techniques, and surface-mount ferrite beads in series with the V_{ISO} and GND_{ISO} pins, the dc-to-dc converters are designed to provide regulated, isolated power that is below CISPR22 Class B limits at full load on a 2-layer PCB with ferrites.

INSULATION LIFETIME

All insulation structures eventually break down when subjected to voltage stress over a sufficiently long period. The rate of insulation degradation is dependent on the characteristics of the voltage waveform applied across the insulation, as well as on the materials and material interfaces.

The two types of insulation degradation of primary interest are breakdown along surfaces exposed to the air and insulation wear out. Surface breakdown is the phenomenon of surface tracking and the primary determinant of surface creepage requirements in

system level standards. Insulation wear out is the phenomenon where charge injection or displacement currents inside the insulation material cause long-term insulation degradation.

Surface Tracking

Surface tracking is addressed in electrical safety standards by setting a minimum surface creepage based on the working voltage, the environmental conditions, and the properties of the insulation material. Safety agencies perform characterization testing on the surface insulation of components that allows the components to be categorized in different material groups. Lower material group ratings are more resistant to surface tracking and, therefore, can provide adequate lifetime with smaller creepage. The minimum creepage for a given working voltage and material group is in each system level standard and is based on the total rms voltage across the isolation, pollution degree, and material group. The material group and creepage for the ADuM5020 and ADuM5028 are presented in [Table 9](#) and [Table 10](#).

Insulation Wear Out

The lifetime of insulation caused by wear out is determined by its thickness, material properties, and the voltage stress applied. It is important to verify that the product lifetime is adequate at the application working voltage. The working voltage supported by an isolator for wear out may not be the same as the working voltage supported for tracking. The working voltage applicable to tracking is specified in most standards.

Testing and modeling show that the primary driver of long-term degradation is displacement current in the polyimide insulation causing incremental damage. The stress on the insulation can be grouped into broad categories, such as dc stress, which causes very little wear out because there is no displacement current, and an ac component time varying voltage stress, which causes wear out.

The ratings in certification documents are usually based on a 60 Hz sinusoidal waveform because this stress reflects isolation from line voltage. However, many practical applications have combinations of 60 Hz ac and dc across the barrier as shown in [Equation 1](#). Because only the ac portion of the stress causes wear out, the equation can be rearranged to solve for the ac rms voltage, as shown in [Equation 2](#). For insulation wear out with the polyimide materials used in these products, the ac rms voltage determines the product lifetime.

$$V_{RMS} = \sqrt{V_{AC\ RMS}^2 + V_{DC}^2} \quad (1)$$

or

$$V_{AC\ RMS} = \sqrt{V_{RMS}^2 - V_{DC}^2} \quad (2)$$

where:

V_{RMS} is the total rms working voltage.

$V_{AC\ RMS}$ is the time varying portion of the working voltage.

APPLICATIONS INFORMATION

V_{DC} is the dc offset of the working voltage.

Calculation and Use of Parameters Example

The following example frequently arises in power conversion applications. Assume that the line voltage on one side of the isolation is 240 V ac rms and a 400 V dc bus voltage is present on the other side of the isolation barrier. The isolator material is polyimide. To establish the critical voltages in determining the creepage, clearance, and lifetime of a device, see [Figure 27](#) and the following equations.

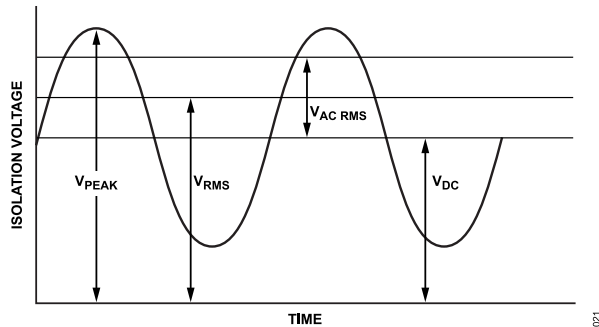

Figure 27. Critical Voltage Example

The working voltage across the barrier from Equation 1 is

$$V_{RMS} = \sqrt{V_{AC\ RMS}^2 + V_{DC}^2}$$

$$V_{RMS} = \sqrt{240^2 + 400^2}$$

$$V_{RMS} = 466\ \text{V}$$

This V_{RMS} value is the working voltage used together with the material group and pollution degree when looking up the creepage required by a system standard.

To determine if the lifetime is adequate, obtain the time varying portion of the working voltage. To obtain the ac rms voltage, use [Equation 2](#).

$$V_{AC\ RMS} = \sqrt{V_{RMS}^2 - V_{DC}^2}$$

$$V_{AC\ RMS} = \sqrt{466^2 - 400^2}$$

$$V_{AC\ RMS} = 240\ \text{V rms}$$

In this case, the ac rms voltage is simply the line voltage of 240 V rms. This calculation is more relevant when the waveform is not sinusoidal.

Note that the dc working voltage limit is set by the creepage of the package as specified in IEC 60664-1. This value can differ for specific system level standards.

OUTLINE DIMENSIONS

Package Drawing (Option)	Package Type	Package Description
RW-16	SOIC_W	16-Lead Standard Small Outline Package
RI-8-1	SOIC_IC	8-Lead Standard Small Outline Package, with Increased Creepage

For the latest package outline information and land patterns (footprints), go to [Package Index](#).

Updated: November 03, 2023

ORDERING GUIDE

Table 21. Ordering Guide

Model ^{1,2}	Temperature Range	Package Description	Packing Quantity	Package Option
ADUM5020-3BRWZ	-40°C to +125°C	16-Lead SOIC Wide	Tube, 47	RW-16
ADUM5020-3BRWZ-RL	-40°C to +125°C	16-Lead SOIC Wide	Reel, 1000	RW-16
ADUM5020-5BRWZ	-40°C to +125°C	16-Lead SOIC Wide	Tube, 47	RW-16
ADUM5020-5BRWZ-RL	-40°C to +125°C	16-Lead SOIC Wide	Reel, 1000	RW-16
ADUM5028-3BRIZ	-40°C to +125°C	8-Lead SOIC (Increased Creepage)	Tube, 80	RI-8-1
ADUM5028-3BRIZ-RL	-40°C to +125°C	8-Lead SOIC (Increased Creepage)	Reel, 1500	RI-8-1
ADUM5028-5BRIZ	-40°C to +125°C	8-Lead SOIC (Increased Creepage)	Tube, 80	RI-8-1
ADUM5028-5BRIZ-RL	-40°C to +125°C	8-Lead SOIC (Increased Creepage)	Reel, 1500	RI-8-1

¹ Z = RoHS Compliant Part.

² For 5 V input operations, use the ADuM5020-5BRWZ and ADuM5028-5BRIZ. For 3.3 V input to 3.3 V output operations, use the ADuM5020-3BRWZ and the ADuM5028-3BRIZ.

EVALUATION BOARDS

Model ^{1,2,3}	Package Description
EVAL-ADuM5020EBZ	ADuM5020 Evaluation Board
EVAL-ADuM5028EBZ	ADuM5028 Evaluation Board

¹ Z = RoHS Compliant Part.

² The EVAL-ADuM5020EBZ is packaged with the ADuM5020-5BRWZ installed and can be used for evaluating the ADuM6020.

³ The EVAL-ADuM5028EBZ is packaged with the ADuM5028-5BRIZ installed and can be used for evaluating the ADuM6028.